

3 x 0...560V, 3 x 0...120A, 40...500Hz
0°...±360°



Accuracy:
0.02% or 0.05%

Calmet sp. z o.o.

- Calmet = **CAL**ibrators + **MET**rology
- founded in **1989**, roots come from LUMEL, big factory of measurement equipment in Poland, Zielona Gora
- designing, production, selling and servicing new kind of calibrators and electric equipment testers
- employs over 25 engineers, including 3 with Ph.D.
- cooperates with University of Zielona Gora; common projects and lectures
- since 1996 – electricity meters testing and power network parameters analysing
- since 2002 – generating and measuring network quality parameters
- since 2006 – automation of electro-utility automatic protective equipment testing
- since 2011 – automatic Test Benches for energy meter testing

Measurement Equipment since 1989

Customer Support in problems solving

Energy meter testers, Current Transformers testers, Power quality analysers

AC/DC Voltage, Current, Power & Resistance Calibrators, Test Benches



1 phase



3 phase



3 phase, 120A



3 phase, 0.05%

Control Software for measurement equipment

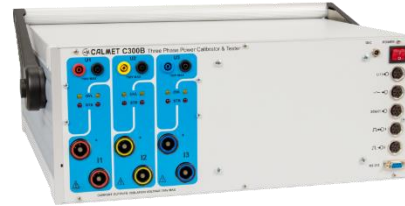
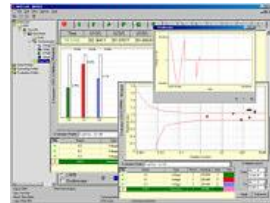
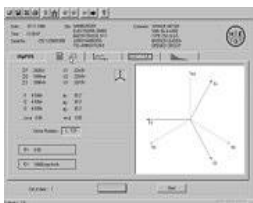

3 phase U,I, ϕ ,P,Q,S,E



1 phase U,I, ϕ ,P,Q,S,E



1 phase U,I, ϕ ,F



Multifunctions DC/AC



3 phase Test Bench



1 / 3phase Phantom Load 0...5A

C300 outputs

C300 inputs

In Manual Mode it is possible to set:

- Voltages up to 3 x 560V
- Currents up to 3 x 120A
(360A in single phase connection)
- Frequency in range 40...500Hz
- Phase angles in range 0...360°
- Wave shapes of signals
- Signal changes in time

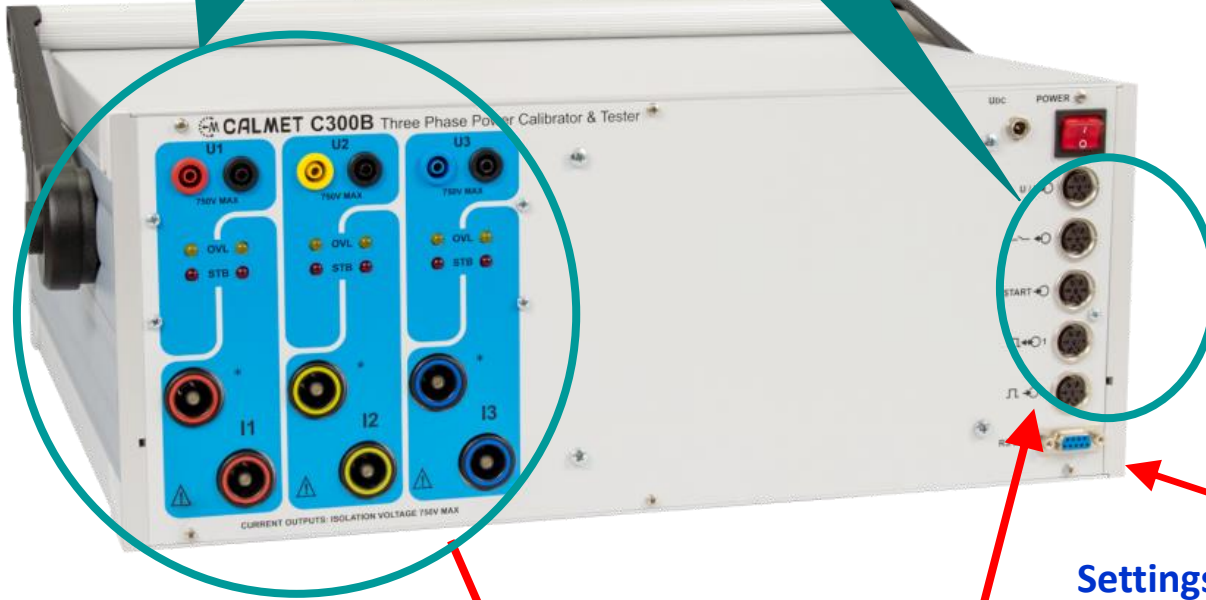

Settings by PC

Only in Automated Mode

Device Under Test

In Automated Mode it is possible to test:

- Electricity meters
- Protective relays
- Current transformers
- Current clamps
- Measurement transducers

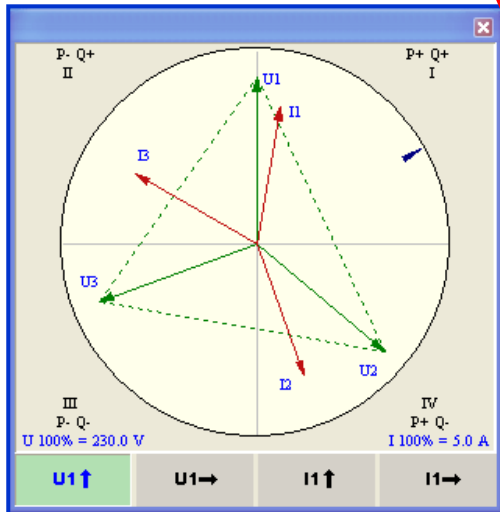

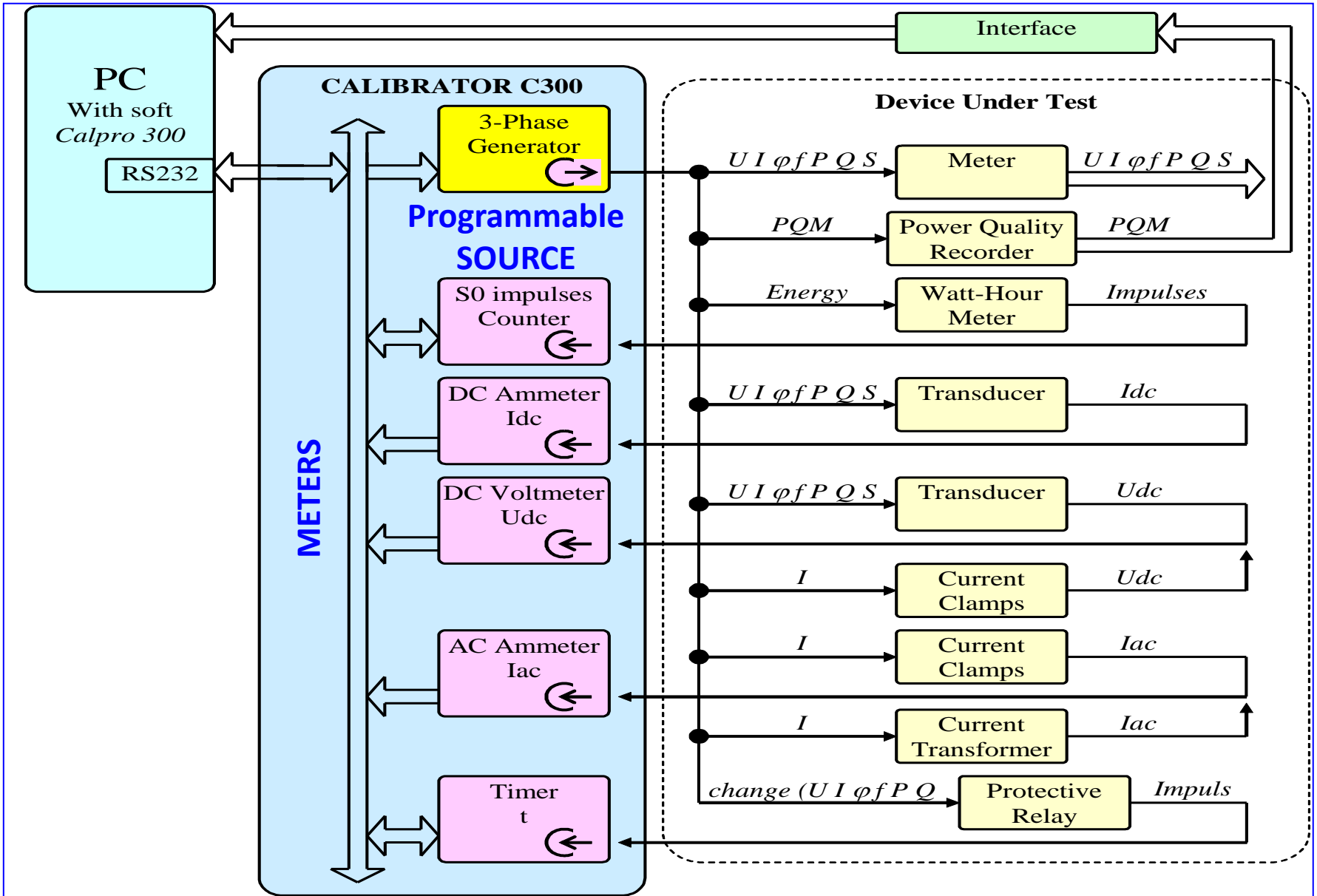

Voltage:

- range: 0.5000V ... 560.000V
- uncertainty: $\pm 0.02\%$
- short term stability: $\pm 0.005\%$
- long term stability: $\pm 0.01\%$
- temp. drift: $\pm 0.0005\%/1^\circ\text{C}$



Current:

- range: 0.001000A ... 120.000A
- uncertainty: $\pm 0.02\%$
- short term stability: $\pm 0.005\%$
- long term stability: $\pm 0.01\%$
- temp. drift: $\pm 0.0005\%/1^\circ\text{C}$

Maximum load:

- 560mA@70V
- 280mA@140V
- 140mA@280V
- 70mA@560V
- sin distortion: 0.05%

Frequency:

- range: 40.000Hz... 500.000Hz
- uncertainty: $\pm 0.005\%$

Phase shift:

- range: 0.00° ... $\pm 360.00^\circ$
- uncertainty: $\pm 0.05^\circ$

Power:

- range: 0...3 x 67200 W,var,VA
- resolution: 0.00001-1W,var,VA

Maximum load:

- 17V@0.5A
- 8.5V@6A
- 3.3V@20A
- 0.70V@120A
- sin distortion: 0.1%

Waveform: harmonics (up to 3200Hz)

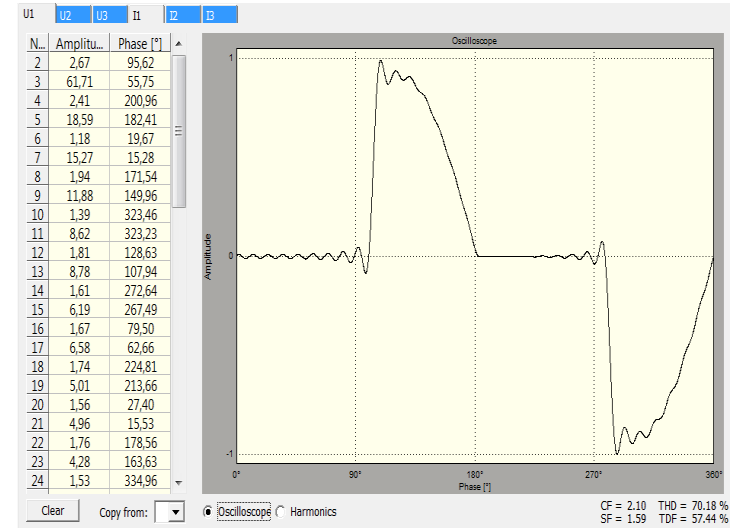

Waveform: interharmonics (up to 9kHz)

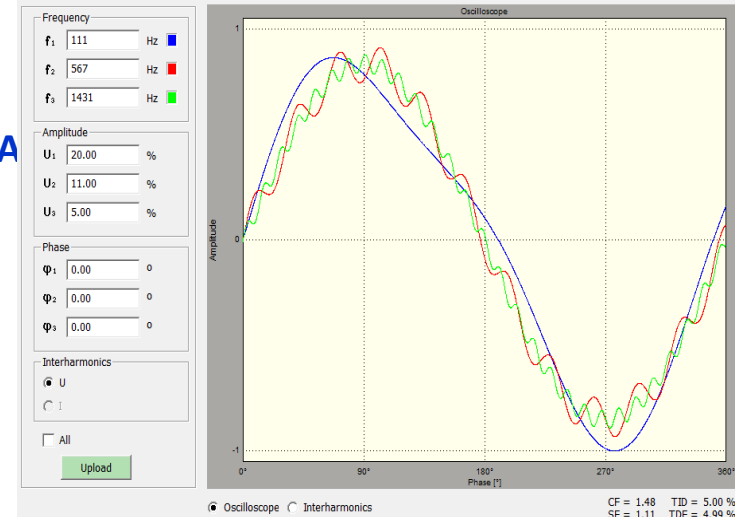

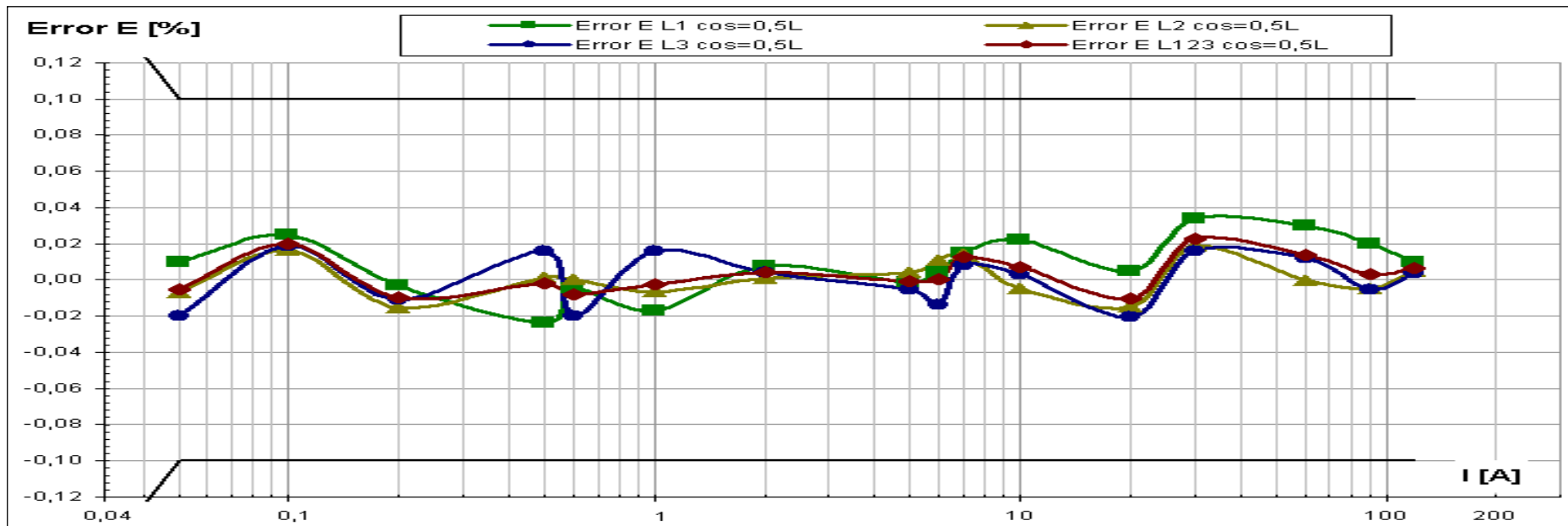
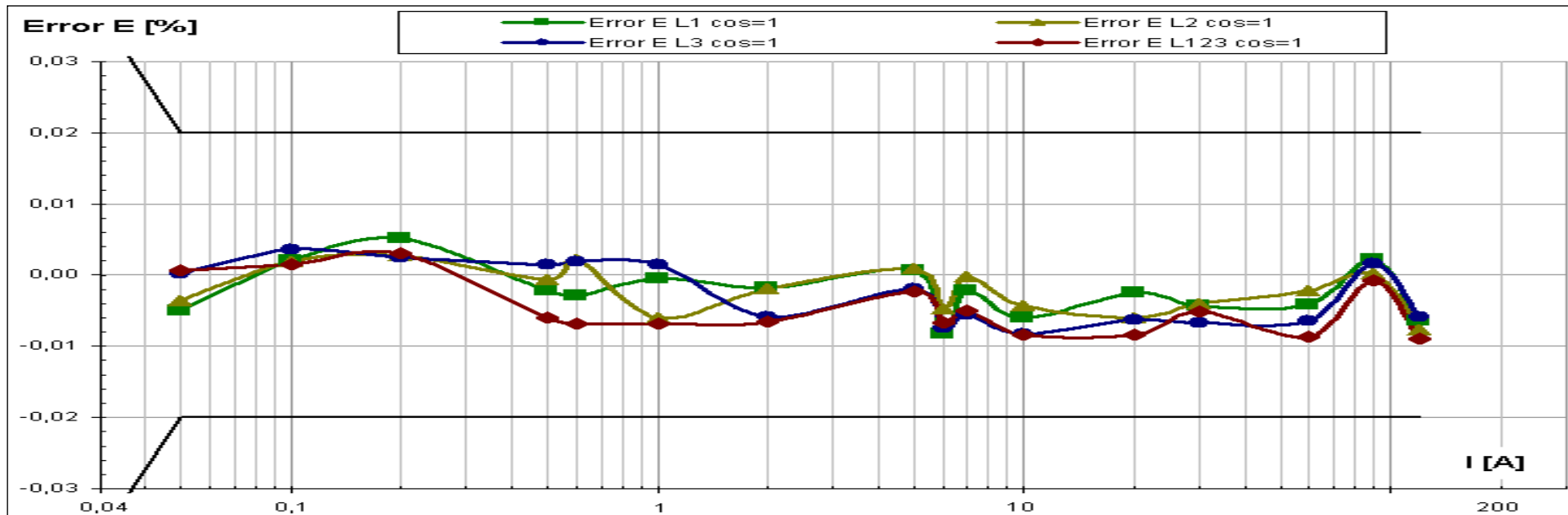

Calibrator output signal change versus time

Single Voltage Dip (100ms)

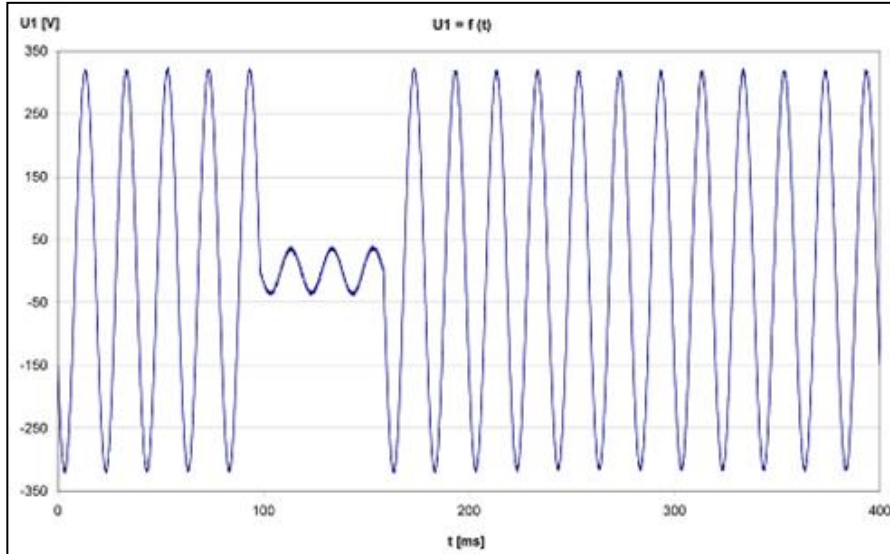

Periodic Voltage Swells (2 periods)

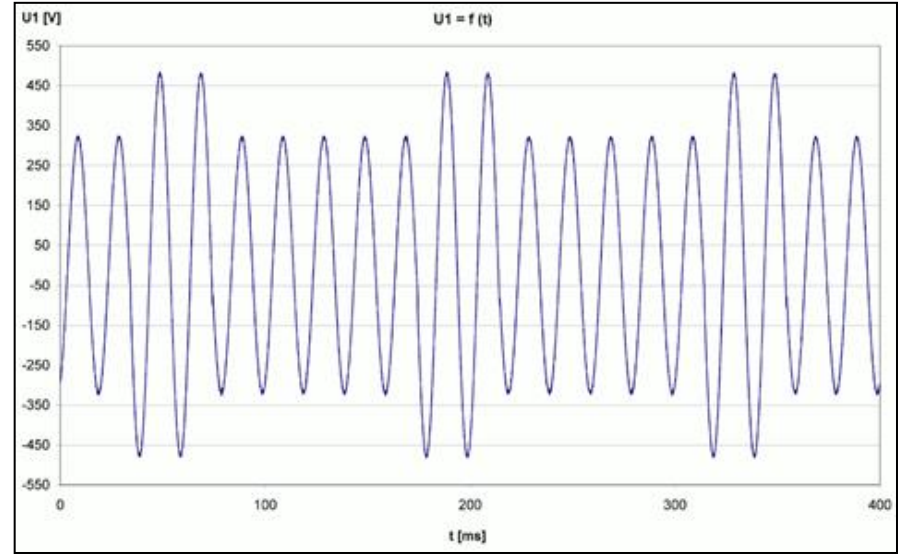

Single Voltage Interruption (100ms)

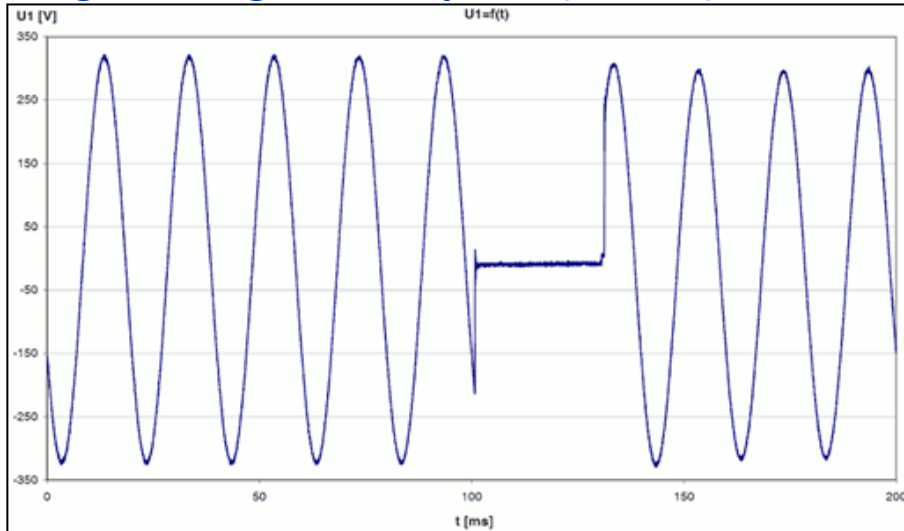

Single Current Shock (1 period)

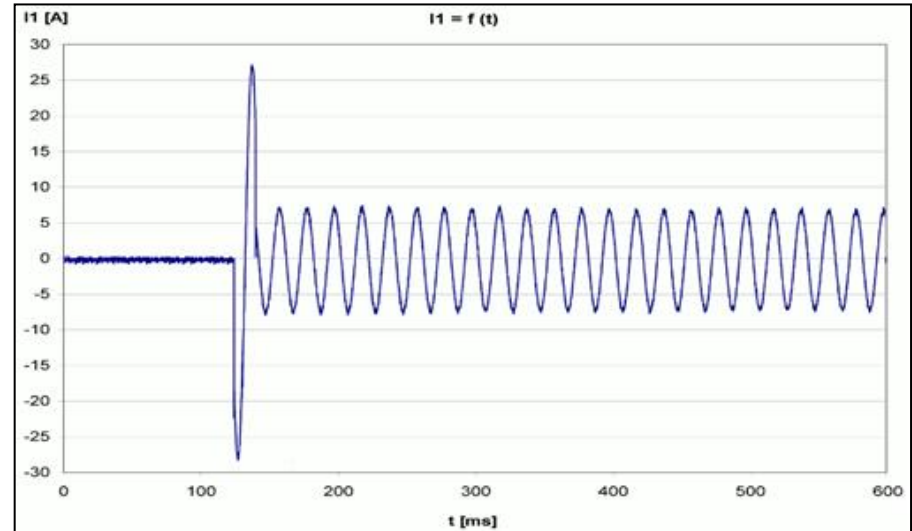

C300 is controlled via RS232/USB by PC Software

The transmission protocol (simple text eg.: U_230,57.70,1[CR][LF]) is available for customers

Calpro 300 Basic version enables setting:

- voltages, currents, frequency, phase angles and powers (Symmetric and Asymmetric)
- Harmonics, Interharmonics and Special Shapes of signals

Function field

Calibrator status field

Operation field

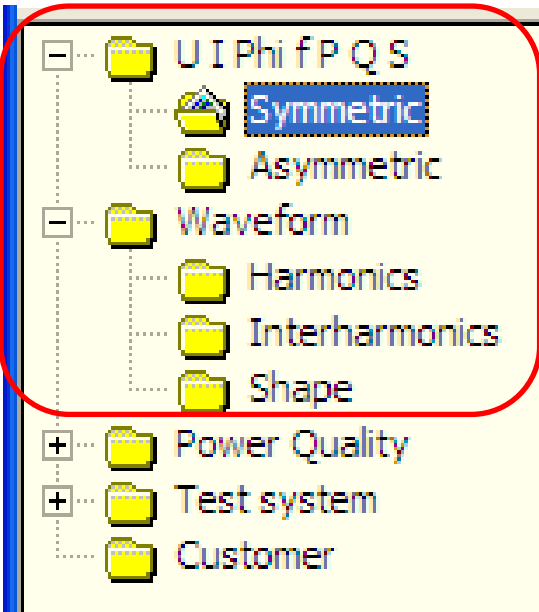

Calpro 300 PC Software allows to create Data Base with:

- **Type** of Device Under Test – properties of device like meter constant, range, class of accuracy etc.













- **Procedure** – set of load points for testing (settings of U, I, φ , f, P, Q, S, harmonics, no. of impulses...)

and then to perform testing:

- **Auto Test** – automatic testing based on **Type** and **Procedure**

and Result evaluation:

- **Result** – presentation in form of **Table** (user editable) or **Diagram** with possibility of printout or export to Excel

Error test		Counting	Counter test															
No	Point name	Time	U1 [V]	U2 [V]	U3 [V]	I1 [A]	I2 [A]	I3 [A]	f [Hz]	Phi1	Phi2	Phi3			Limit [%]	ε [%]	ε_s [%]	OK
1	100A sym cos=1,0	10:57:03	230.000	230.000	230.000	100.000	100.000	100.000	50.000	Cos 1.00 L	Cos 1.00 L	Cos 1.00 L		L123	1.000	-0.485	0.000	✓
2	10A sym cos=1,0	10:58:14	230.000	230.000	230.000	10.0000	10.0000	10.0000	50.000	Cos 1.00 L	Cos 1.00 L	Cos 1.00 L		L123	1.000	-0.343	0.011	✓
3	10A sym cos=0,5L	10:58:44	230.000	230.000	230.000	10.0000	10.0000	10.0000	50.000	Cos 0.50 L	Cos 0.50 L	Cos 0.50 L		L123	1.000	-0.165	0.000	✓
4	1A sym cos=1,0	10:59:15	230.000	230.000	230.000	1.00000	1.00000	1.00000	50.000	Cos 0.50 L	Cos 0.50 L	Cos 0.50 L		L123	1.000	-0.222	0.025	✓
5	10A L1 cos=1,0	11:00:27	230.000	230.000	230.000	10.0000	0.000000	0.000000	50.000	Cos 1.00 L	Cos 1.00 L	Cos 1.00 L		L123	1.000	-0.389	0.009	✓
6	10A L2 cos=1,0	11:01:03	230.000	230.000	230.000	0.000000	10.0000	0.000000	50.000	Cos 1.00 L	Cos 1.00 L	Cos 1.00 L		L123	1.000	-0.326	0.009	✓
7	10A L3 cos=1,0	11:01:38	230.000	230.000	230.000	0.000000	0.000000	10.0000	50.000	Cos 1.00 L	Cos 1.00 L	Cos 1.00 L		L123	1.000	-0.320	0.000	✓
8	10A L1 cos=0,5L	11:02:14	230.000	230.000	230.000	10.0000	0.000000	0.000000	50.000	Cos 0.50 L	Cos 0.50 L	Cos 0.50 L		L123	1.000	-0.225	0.055	✓
9	10A L2 cos=0,5L	11:02:52	230.000	230.000	230.000	0.000000	10.0000	0.000000	50.000	Cos 0.50 L	Cos 0.50 L	Cos 0.50 L		L123	1.000	-0.103	0.009	✓
10	10A L3 cos=0,5L	11:03:30	230.000	230.000	230.000	0.000000	0.000000	10.0000	50.000	Cos 0.50 L	Cos 0.50 L	Cos 0.50 L		L123	1.000	-0.135	0.040	✓

Calpro 300 TS (Test System) version enables automatic testing the following devices:

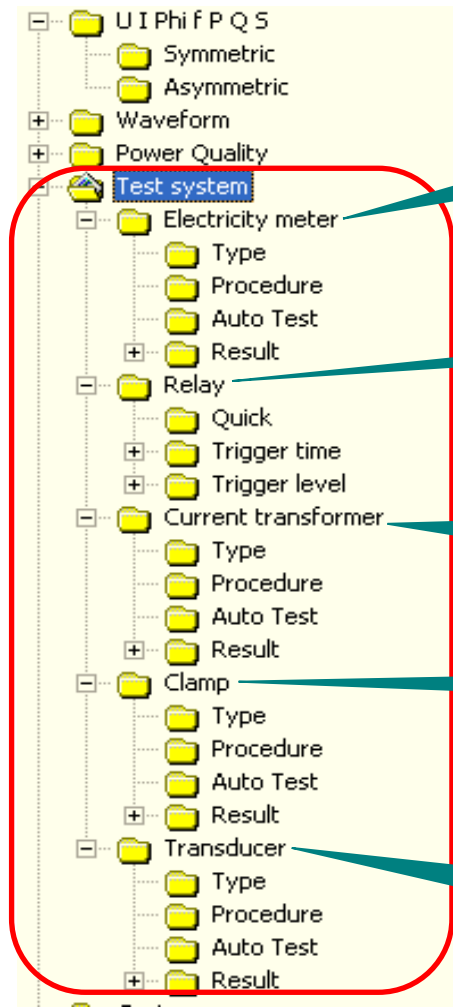

Electricity meter function for automatic testing of meters

Relay function for automatic testing of protective relays

Current transformer function for automatic testing of current transformers

Clamp function for automatic testing of current clamps

Transducer function for automatic testing of measurement transducers

Testing Energy meter with C300 as a Source and Reference

Reference Energy is calculated on base of equation:

$$E_{Ref} = U \times I \times \cos\varphi(\sin\varphi) \times t$$

Where:

E_{ref} – reference energy

U – set value of voltage

I – set value of current

$\cos/\sin\varphi$ – power factor

t – time of impulses counting

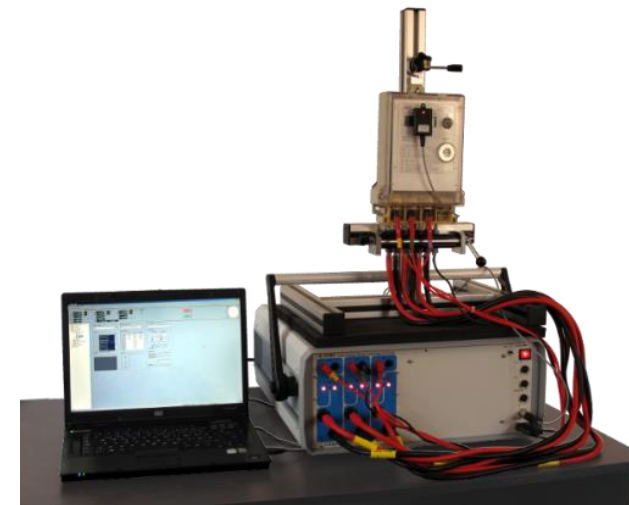
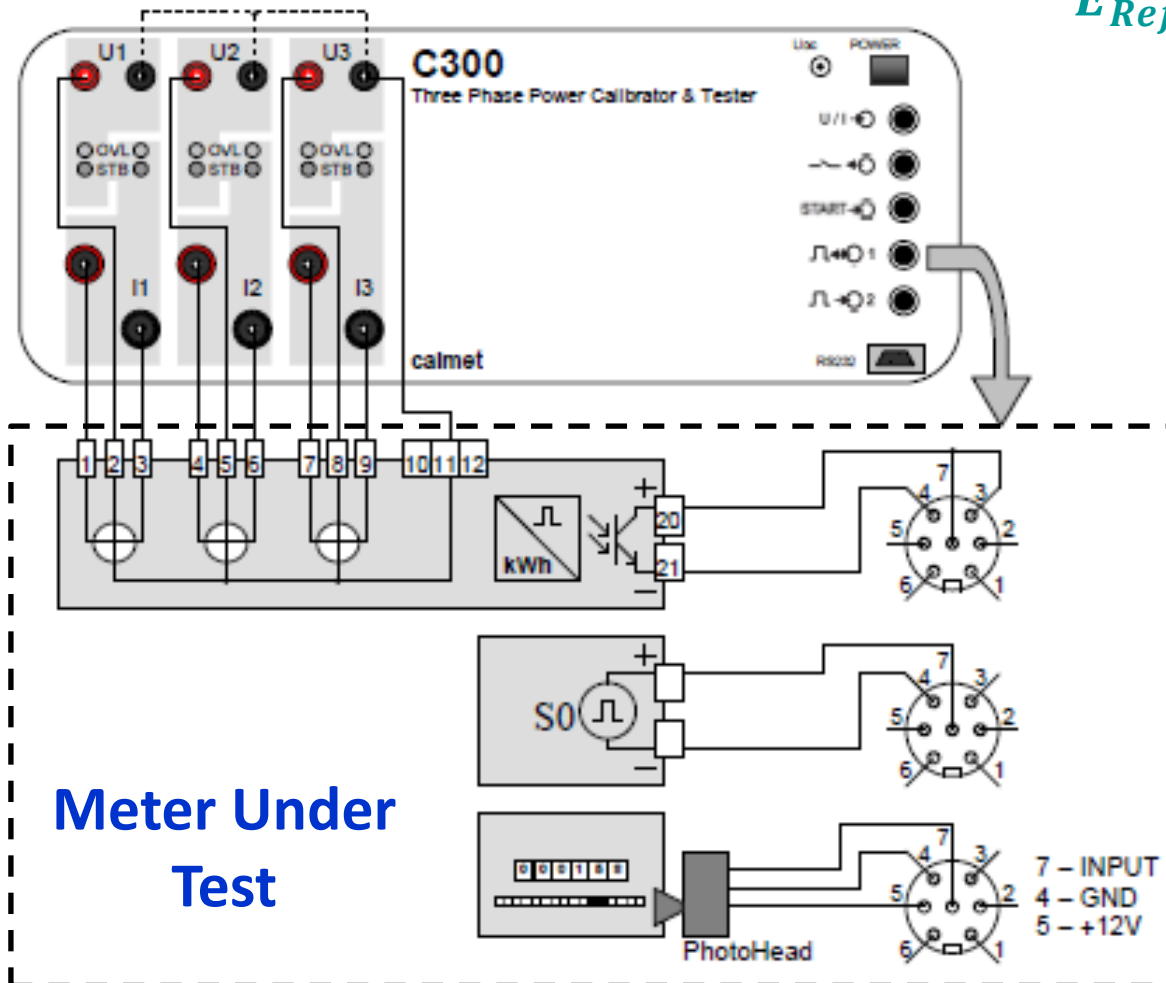

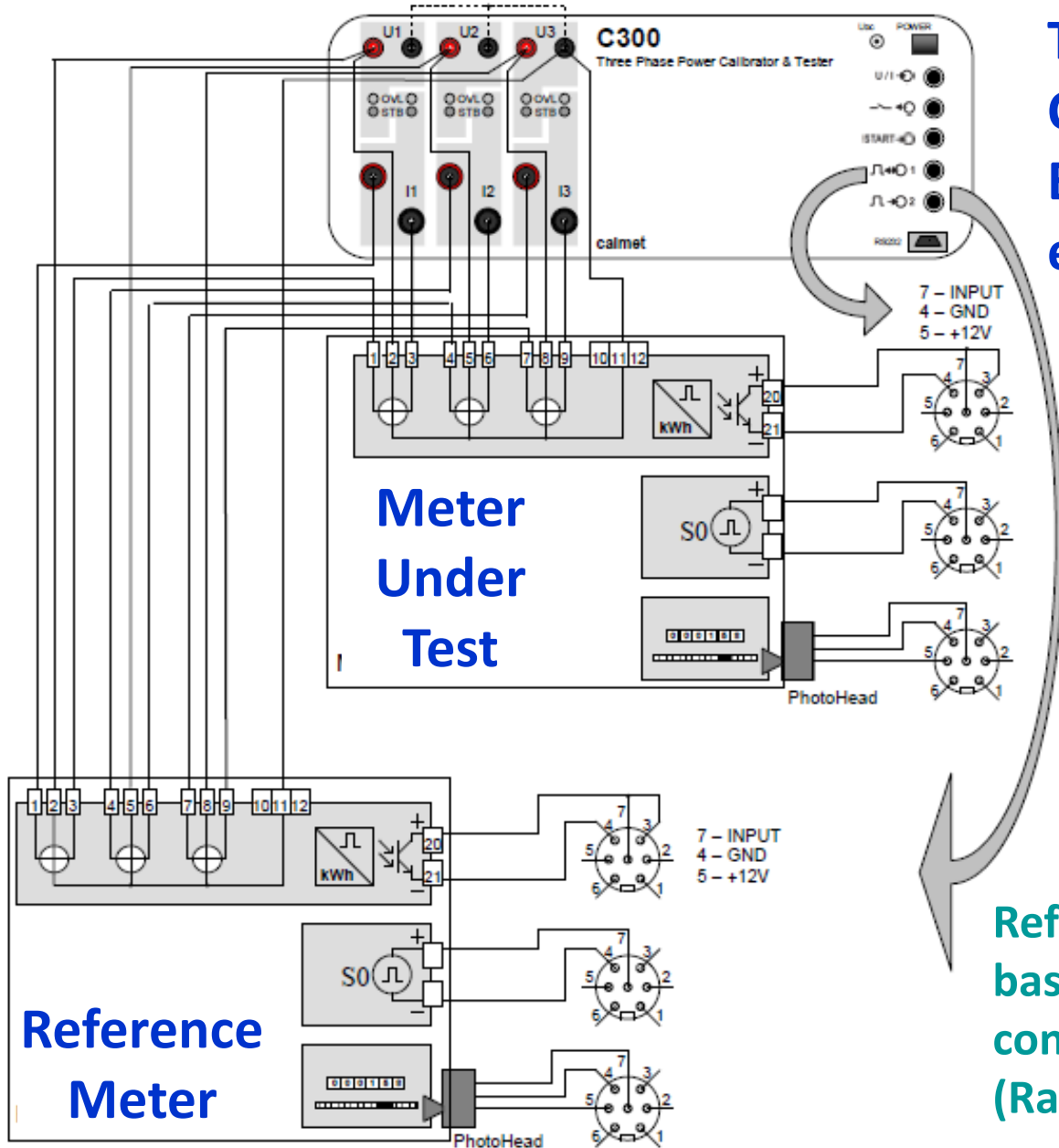

Testing Energy meter with C300 as a Source and Error Calculator with external Reference Meter

Reference Energy is calculated on base of number of impulses and constant of any Reference Meter (Radian, ZERA, MTE....)

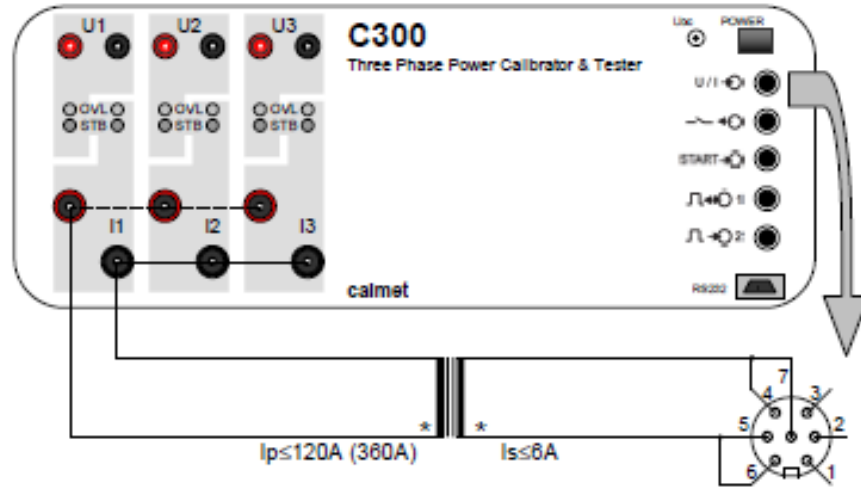

$I_{pmax} = 120A$
when using current I1 only

$I_{pmax} = 360A$
when shorted I1, I2 and I3
HI terminals and I1, I2, I3
LO terminals



Up to 360A in parallel



CT 100A / 5A

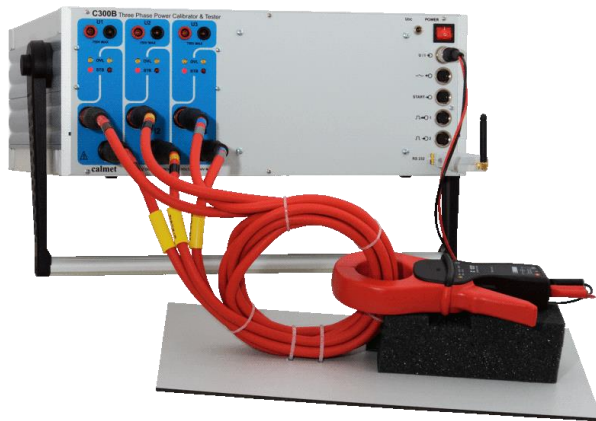

1000A clamp and sum of
currents

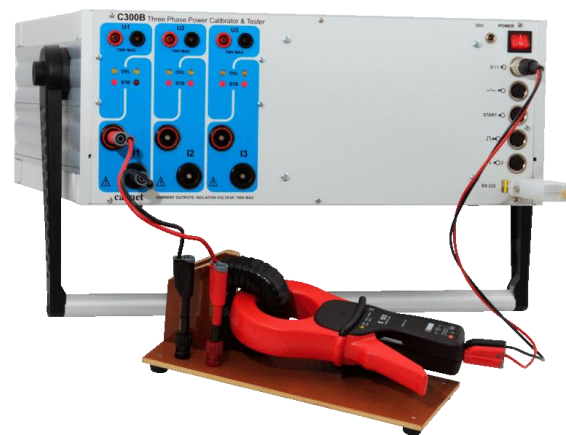

1000A clamp with 100 turns
coil



100A clamp and 100A cable

All completed Calmet C300B Calibrator's set consists of:

- **C300B calibrator class 0.02 or 0.05,**
- **power cord,**
- **Calpro 300 Soft – Basic PC Soft,**
- **USB / RS232 adapter,**
- **fuse T4A, 250V, 5x20 (2units),**
- **EA36 set of safety voltage cables (6units) and current cables up to 20A (6units),**
- **EA21 set of accessories for safety cables (12units banana plug +12units Cu),**
- **AD300 sockets adapter,**
- **C091A T3475-001 plug Amphenol for Calibrator inputs,**
- **operation manual of calibrator and software (2units),**
- **warranty card,**
- **calibration certificate.**

Optionally for Calmet C300B Calibrator are available:

- computer Laptop
- Calpro 300TS PC Soft for automatic test of electric equipment,
- Calpro 300PQ PC Soft for programming of Power Quality parameters,
- C300LabView-LabView Driver for C300B Calibrator,
- AKD300 current cables up to 120A (6units) with set (18units) of replaceable terminals,
- KAS300 transportation case for portable work,
- CF106H photo head with holder for inductive meter and meter with LED,

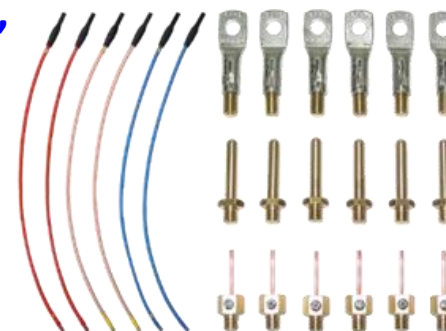

Optionally for Calmet C300B Calibrator are available:

- MPX8 Eight Inputs Multiplexer with MPX8 PC Soft for simultaneously testing up to eight electricity meters,
- ER10 rack for hanging of meter under test,
- ER10H.3 rack for hanging of meter with 3-phase quick connection device,
- ZW100/10A coil 100 turns / 10A,
- ZW10/20A coil 10 turns / 20A,
- RS232 – Bluetooth adapter for wireless connection.

